



JCPT0807DC

Dingli









Elektrisk sakselift
JCPT0807DC

Elektrisk sakselift JCPT0807DC

STANDARD UDRUSTNING

- Proportional styring
- Automatisk hul-i-vej beskyttelse
- Selv-låsende låge i arb.kurven
- Kørbar i fuld højde
- Ikke-afsmittende dæk
- 2 WD
- Automatisk bremsesystem
- Nødsænkningssystem
- Nødstop knap
- Cylinder holde ventil
- Indbygget diagnose system
- Overbelastnings sensor med alarm
- Tilt sensor med alarm
- Bevægelses alarm
- Horn
- Timetæller
- Sikkerheds beslag
- Gaffeltruck lommer
- Foldbart rækværk
- Udskydelig platform
- Oplade beskyttelse
- Blinkende flash lys

SPECIFIKATIONER

	Max last i kurven.....	230 kg
	Max last på udskud.....	113 kg
	Max antal personer.....	2
	Arbejdshøjde.....	7,8 m
	Platformshøjde.....	5,8 m
	Total længde	1,86 m
	Total bredde	0,76 m
	Total højde (Rækværk oppe).....	2,18 m
	Total højde (Rækværk nede).....	1,84 m
	Arbejdskurv størrelse.....	1,67 x 0,74 m
	Udskud størrelse.....	0,90 m
	Frihøjde (Sammenpakket)	0,083 m
	Frihøjde (Hævet)	0,016 m
	Akselafstand.....	1,36 m
	Venderadius (indvendig)	0 m
	Venderadius (udvendig)	1,64 m
	Køremotorer	24 V / 0,5 kW
	Løftemotor	24 V / 2,0 kW
	Hastighed (Sammenpakket)	4,5 km / t
	Hastighed (Hævet)	0,8 km / t
	Op / Ned Hastighed.....	27 / 22 sek
	Batterier	4 x 6 V / 210 Ah
	Integreret lader.....	24 V / 25 A
	Stigningsevne	25 %
	Max arb. skråning	1,5 - 3 °
	Hjul	Ø 305 x 100 mm
	Vægt	1415 kg

OPTIONER

- Arbejdslys
- Luftslange i arbejdskurv
- Strømutag i arbejdskurv

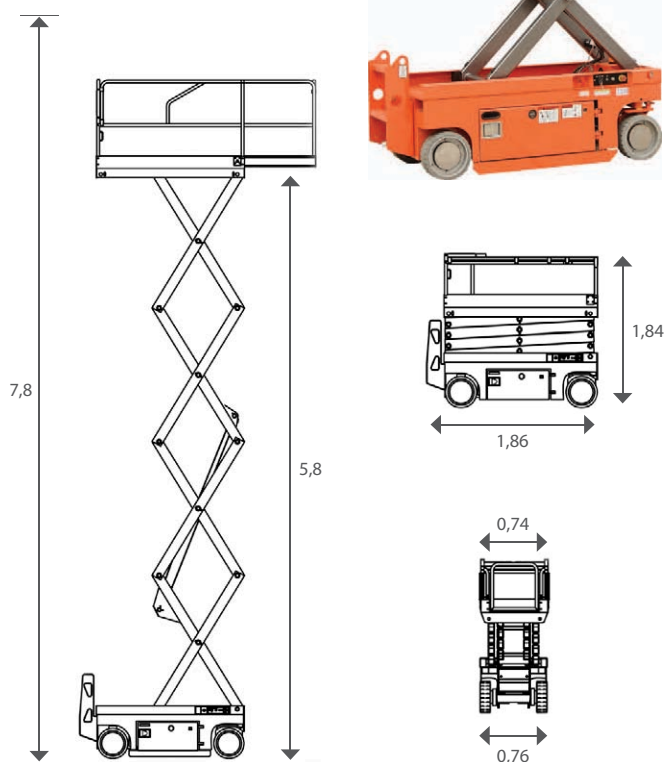

 This product is available with the CE mark confirming compliance with all relevant European Machinery Directives

www.mj-hyd.dk